

AUTOMATED PLASMA CUTTING SYSTEMS

Victor[®] Thermal Dynamics[®] introduces
AUTO-CUT[®] XT SYSTEMS

The new Auto-Cut XT systems deliver the next step in flexibility and reliability in heavy plate cutting applications.

- ▶ MaximumLife[®] Parts to Lower Operating Costs
- ▶ Increased Productivity for Greater Profits
- ▶ Water Mist Secondary (WMS[®]) for Low Cost, High Quality Cutting on Non-Ferrous Metals



We Bring Intelligence to the Table.[™]

Victor® Thermal Dynamics® introduces

AUTO-CUT® XT SYSTEMS

Auto-Cut 200 XT & 300 XT systems deliver premium cut performance on both mild steel and non-ferrous metals. These power supplies are designed for reliable, low cost operation. Features like the XT™ 301 consumable parts cartridge and the Machine Status Message Center make these models easy to operate.

The Flexibility to Cut Thick or Thin on All Kinds Of Metals

XT-301 consumable parts are available for cutting metals from gauge (1.0 mm) to a 1" (25 mm) plate [1¼" (35 mm) for Auto-Cut 300 XT]. Auto-Cut XT systems with the XT-301 torch, are normally operated using economical air plasma and air shield gas for cutting mild steel and most non-ferrous metals. This results in high quality surface finishes and low dross cuts.

For even better cut quality on mild steel, Auto-Cut XT models offers O₂ plasma cutting capability. For lowest cost non-ferrous metal cutting and unmatched cut quality, use our unique Water Mist Secondary (WMS®) process with nitrogen plasma and water shield.

If heavy non-ferrous metal cutting is required, switch to Ar-H₂ (H35) and Nitrogen shield for premium non-ferrous metal performance up to 1" (25 mm).



Cut fast with Air-Air

Victor Thermal Dynamics' patented XT Torch Consumable Technology is ideal for cutting from gauge (1.0 mm) to 1" (25 mm) [1¼" (35 mm) for Auto-Cut 300 XT]. Excellent quality cuts will be achieved on both ferrous and non-ferrous metals at higher speeds.

- Small heat affected zone and smooth cutting edge surface.
- Narrow kerf for tighter angles and radiuses at high speeds.
- Wide low dross parameter windows
- Higher arc density for faster speeds without sacrificing cut quality.
- Faster cuts with Air/Air on Stainless Steel

Relative Cutting Speed

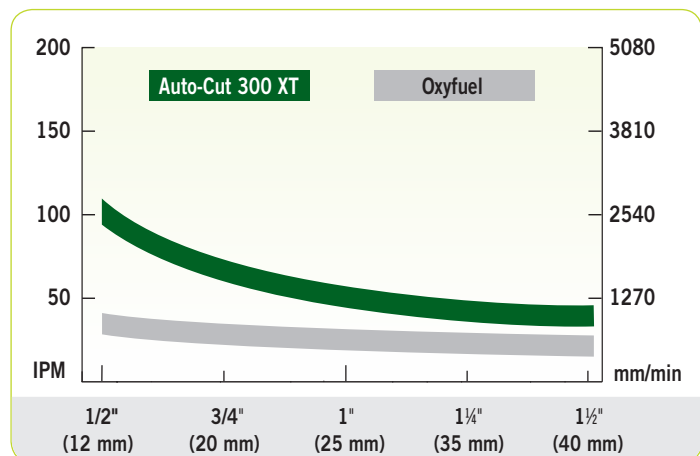

Auto-Cut XT systems offer maximum productivity with reliability and ease

Productivity

- High cut speed to produce more parts per hour.
- With Water Mist Secondary (WMS) the cut speed can be up to 3 times faster than with similar cutting systems.
- Highest kW output in its class.
- Outstanding parts life.
- Reduced downtime during parts changes due to the SpeedLok cartridge design of the XT™ 301-Torch.

Reliability

- Exhaustive lab testing and field trials ensure on-going performance and reliability.

Technology

- Microprocessor controlled to produce the best cut quality.
- Precision torch design offers the best cut quality in its class.
- Higher cut speed than H35 with the use of N₂/H₂O on non-ferrous metals.

XT 301-Torch Technology

Victor Thermal Dynamics XT Torch Technology delivers productivity and reliability.

- Keyless consumable cartridges for rapid process changes.
- Precision construction insuring accurate re-centering of consumable cartridge after parts change.
- Rapid engagement SpeedLock retaining collar.
- Liquid cooled consumable parts electrical connections.
- Spring loaded leak-less coolant tube design.
- Increased cooling of tip and electrode.
- Improved life through patented alignment control.

Ease of Use

- Fast and easy installation.
- Simple set-up and user-friendly gas console.
- SpeedLok™ quick-change consumable design.
- Easy to identify and troubleshoot problems.

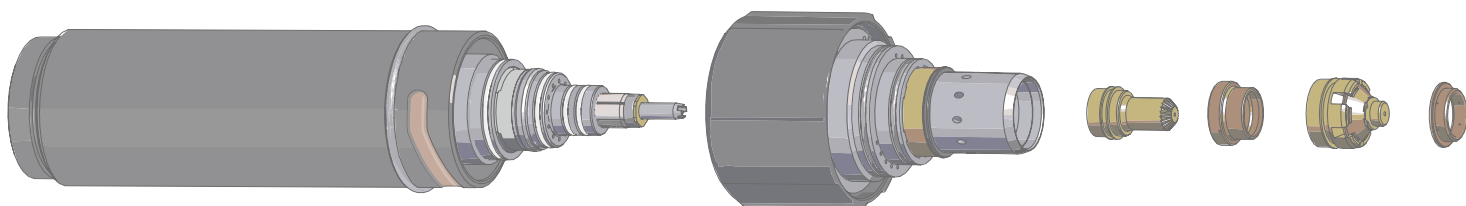

We Bring Intelligence to the Table.™

Full Featured Gas Control

Plasma, secondary pressures and flows are precisely controlled at the power supply with individual single stage regulators. Changing from the secondary gas to water mist secondary is simple with the front panel mounted selector switch.

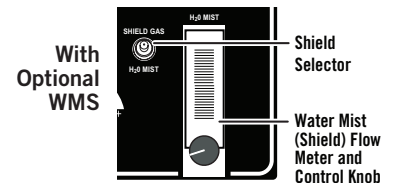
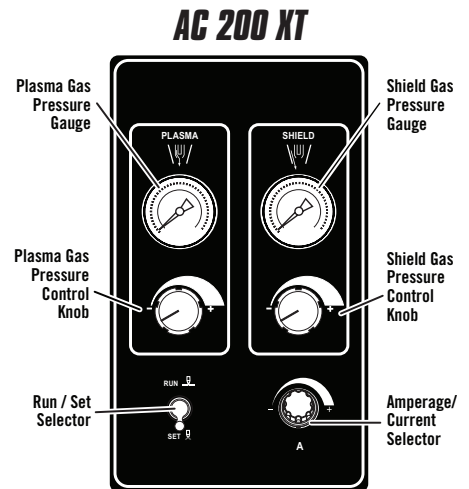
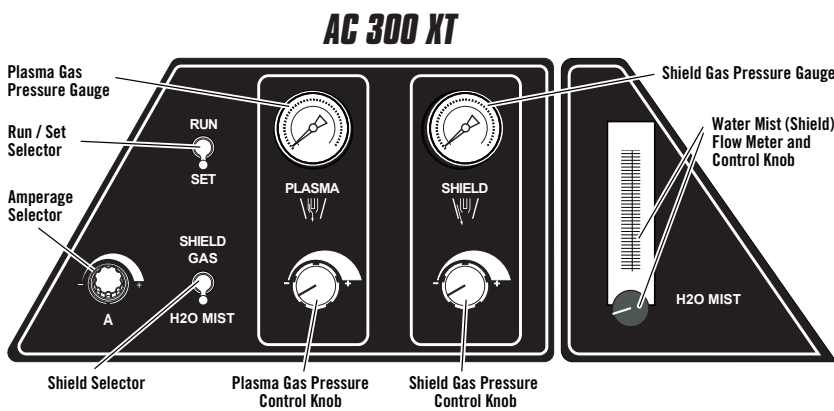

Water Mist Secondary (WMS) optimizes non-ferrous metal cutting (optional for Auto-Cut 200 XT)

WMS Benefits

- Excellent non-ferrous metal cut quality using N₂ as plasma gas and ordinary tap water as the secondary.
- Lowest operating cost.
- Dross-free cutting from gauge (1.0 mm) to 3/4" (20 mm).
- Oxide-free cut face surface.
- Wide parameter window.
- Easy-to-use.
- High cut speeds compared to H35 cutting.
- Standard with AC 300 XT, Optional with AC 200 XT.

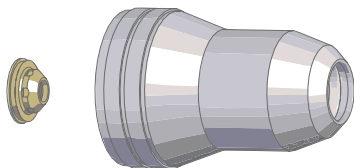

N₂ / H₂O Plasma on Non-Ferrous

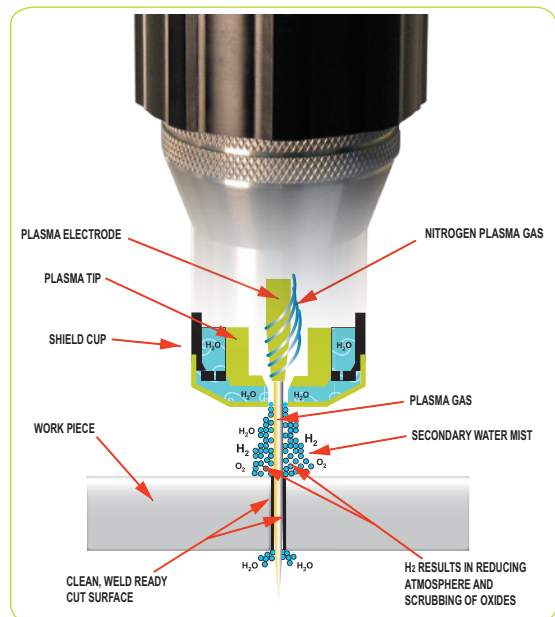

Victor® Thermal Dynamics® introduces

AUTO-CUT® XT SYSTEMS

Specifications



Auto-Cut 200 XT

Unit Specifications*

Rated Output (Amps)	200 A
Output Range (Amps)	5-200 A
Output (Volts)	170 V
Input Volts (Volts, Phase, Hertz)	380 V, 3 ph, 50-60 Hz, 400 V, 3 ph, 50-60 Hz, 480 V, 3 ph, 50-60 Hz
Input Amps (Amps, Volts)	63 A @ 380 V 60 A @ 400 V 50 A @ 480 V
Duty Cycle (@ 104°F / 40° C)	100% (40 kW)
Max OCV	425 V
Plasma Gas	Air, O ₂ , Ar-H ₂ , N ₂ @ 120 psi (8.3 bar)
Shield Gas	Air, N ₂ @ 120 psi (8.3 bar)
Water Mist Secondary (WMS) (Optional)	H ₂ O @ 10 GPH (0.6 l/min)
Power Supply Weight	475 lbs (215 kg)
Dimensions (H x W x D)	48.0" x 27.5" x 40.6" (1219 mm x 698 mm x 1031 mm)
Certifications	CSA, CE, CCC

Cutting Capacity

	Mild Steel	Stainless Steel	Aluminum
Production Piercing	1" (25 mm)	1" (25 mm)	1" (25 mm)
Maximum Piercing	1¼" (35 mm)	1¼" (35 mm)	1¼" (35 mm)
Maximum Edge Start	2" (50 mm)	2" (50 mm)	2" (50 mm)



Auto-Cut 300 XT

Unit Specifications*

Rated Output	300 A
Output Range	5-300 A
Output	180 V
Input Volts	380 V, 3 ph, 50-60 Hz, 400 V, 3 ph, 50-60 Hz, 480 V, 3 ph, 50-60 Hz
Input Amps	97 A @ 380 V 93 A @ 400 V 76 A @ 480 V
Duty Cycle (@ 104°F / 40° C)	100% (60 kW)
Max OCV	425 V
Plasma Gas	Air, O ₂ , Ar-H ₂ , N ₂ @ 120 psi (8.3 bar)
Shield Gas	Air, N ₂ @ 120 psi (8.3 bar)
Water Mist Secondary (WMS)	H ₂ O @ 10 GPH (0.6 l/min)
Power Supply Weight	590 lbs (268 kg)
Dimensions (H x W x D)	54.9" x 27.5" x 40.6" (1371 mm x 698 mm x 1031 mm)
Certifications	CSA, CE, CCC

Cutting Capacity

	Mild Steel	Stainless Steel	Aluminum
Production Piercing	1¼" (35 mm)	1¼" (35 mm)	1¼" (35 mm)
Maximum Piercing	1½" (40 mm)	1½" (40 mm)	1½" (40 mm)
Maximum Edge Start	2¾" (70 mm)	2¾" (70 mm)	2¾" (70 mm)

* Subject to change without notice

Victor® Thermal Dynamics® introduces

AUTO-CUT® XT SYSTEMS

Cut Speeds with Reliable Performance

Cutting Speed Chart For Auto-Cut XT Systems

Material	Thickness (Inch)	Speed (IPM)	Amps	Plasma /Shield	Thickness (mm)	Speed mm/min.
Mild Steel	21 ga	500	55	Air/Air	1	11500
	10 ga	190			3	5460
	3/16	130			5	3180
	1/4	150	100	Air/Air	6	4150
	1/2	75			12	1960
	3/4	30			20	720
	1	20			25	520
	3/8	130	200	Air/Air	10	3190
	1/2	100			12	2710
	3/4	60			20	1430
	1	35			25	920
	1/2	110	300	Air/Air	12	2790
	3/4	75			20	1960
	1	50			25	1300
	1-1/4	35			35	920
1-1/2	20			38	510	
2	8			50	220	
2-3/4	4			70	100	
Stainless Steel	16 ga	350	55	Air/Air	1.5	9750
	10 ga	100			4	2180
	3/16	60			5	1450
	1/4	100	100	Air/Air	6	3020
	3/8	65			10	1580
	1/2	45			12	1260
	1/4	60	100	N ₂ /H ₂ O	6	1750
	3/8	50			10	1210
	1/2	35			12	970
	3/4	60	200	N ₂ /H ₂ O	20	1450
	1	40			25	1000
	3/4	100	300	Air/Air	20	3020
	1	60			25	1750
	1-1/4	40			35	1060
	Aluminum	16 ga	400	55	Air/Air	2
3/16		100			5	2360
1/4		100	100	Air/Air	6	2650
1/2		45			12	1310
3/4		35			20	890
1/4		60	100	N ₂ /H ₂ O	6	1640
3/8		50			10	1210
1/2		35			12	970
3/4		70	200	N ₂ /H ₂ O	20	1700
1		60			25	1000
3/4		90	300	Air/Air	20	1600
1		70			25	1490
1-1/4		45			35	1320

Note: The cutting speed chart includes preliminary data and is subject to change without notice. Take care in comparison. The speeds noted above are best cut speeds. Often, competitors show maximum cutting speeds. Although much higher speeds can be achieved, edge quality and bevel angle may be compromised. The capabilities shown in this table were obtained by using new consumables, correct gas and current settings, accurate torch height control and with the torch perpendicular to the work piece. The operating chart does not list all processes available for the Auto-Cut 200 & 300 XT. Please contact Victor Thermal Dynamics for more information.



WMS Cut Example

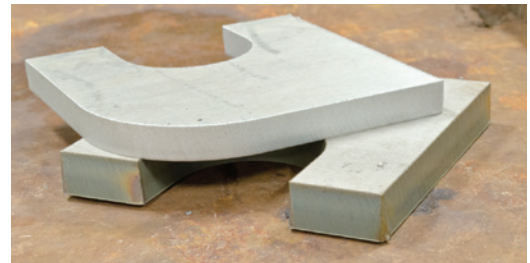

Example for 5/8" (15 mm) & 3/4" (20 mm) on Aluminum

Air/Air Cut Example



Example for 3/4" (20 mm) cutting with Air/Air on Mild Steel

